

4 OBJETS POUR UN TYPE DE SOLIDE

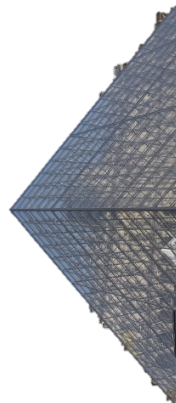

4 OBJETS POUR UN TYPE DE SOLIDE

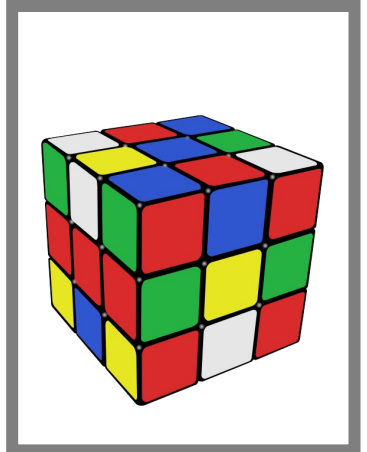
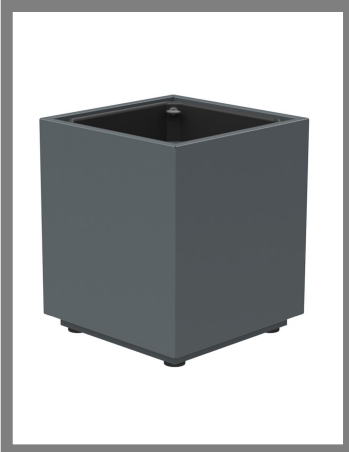

JEU PORTRAIT SOLIDES

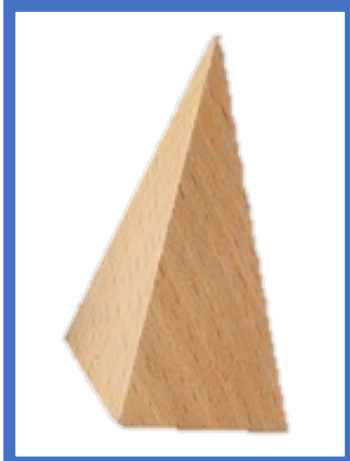
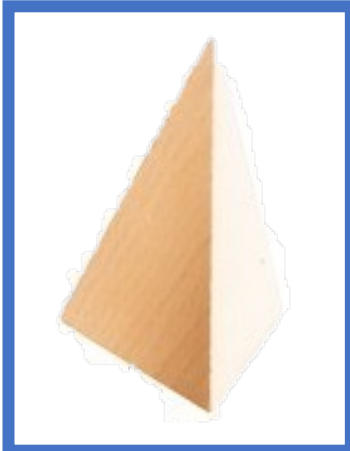

JEU PORTRAIT SOLIDES

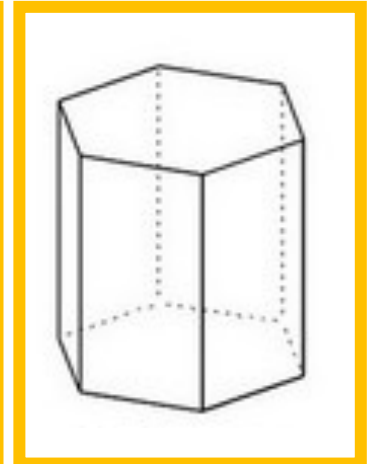
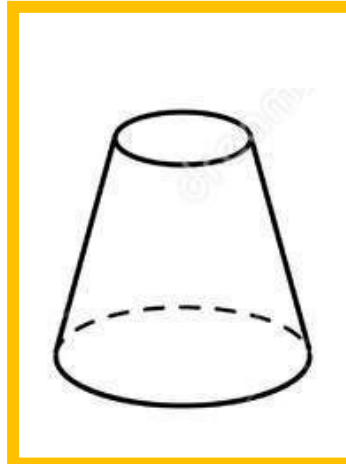
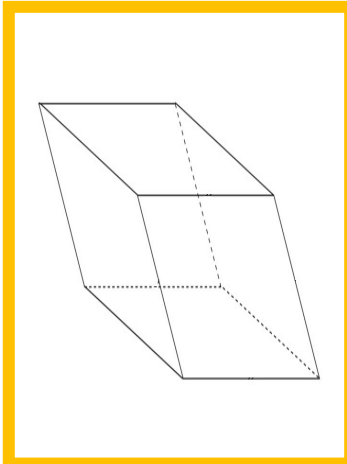
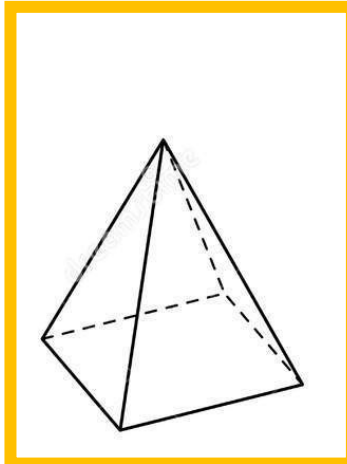
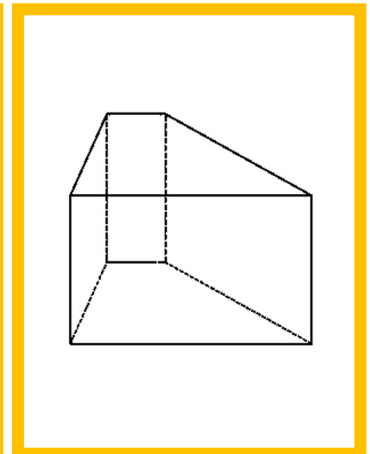
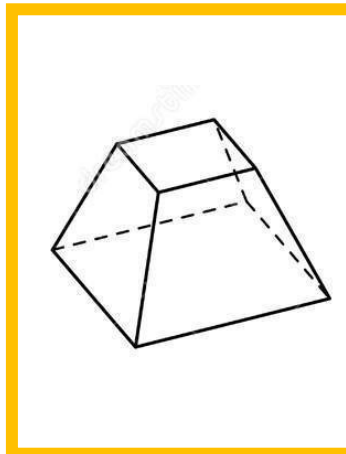
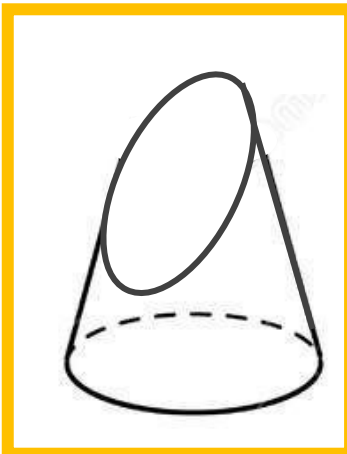
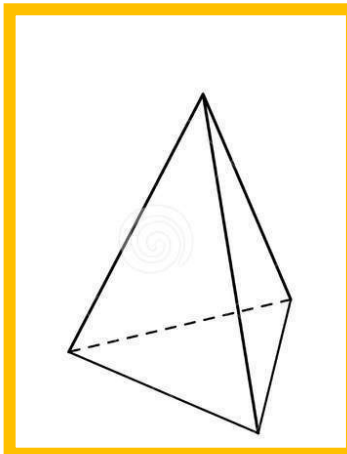
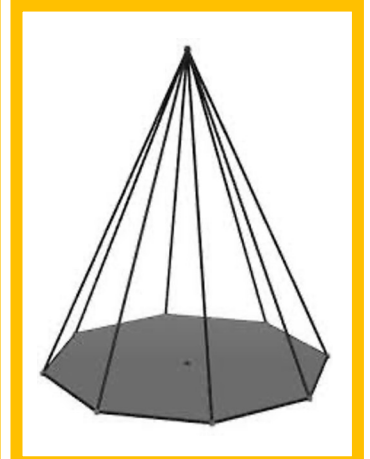
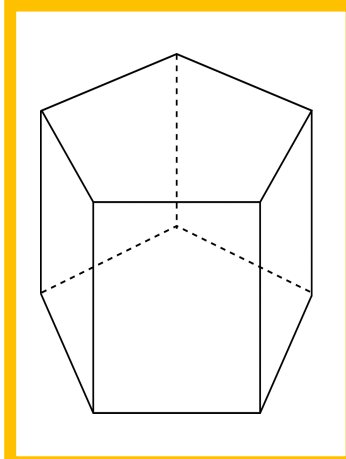
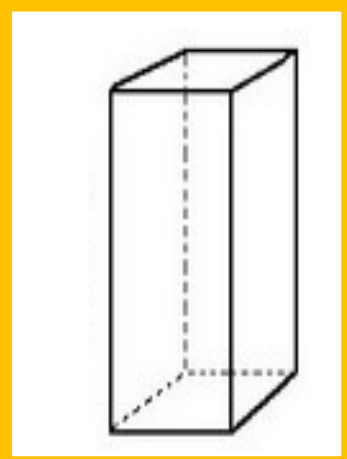
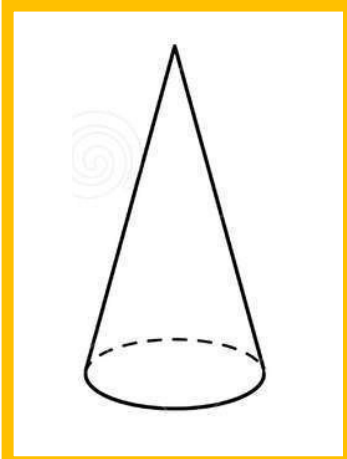
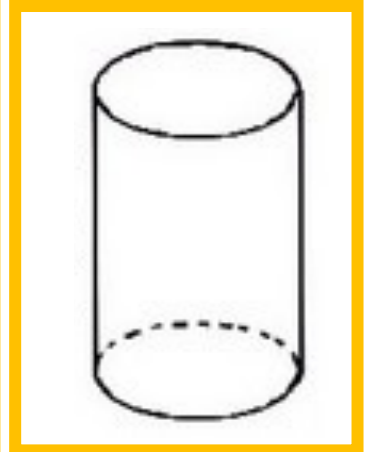
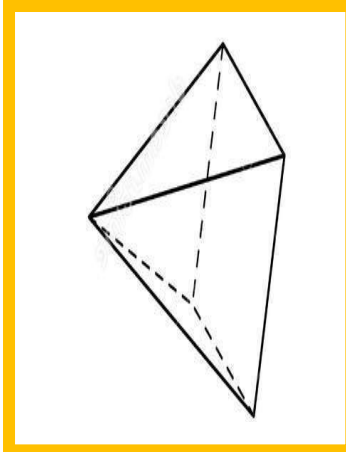
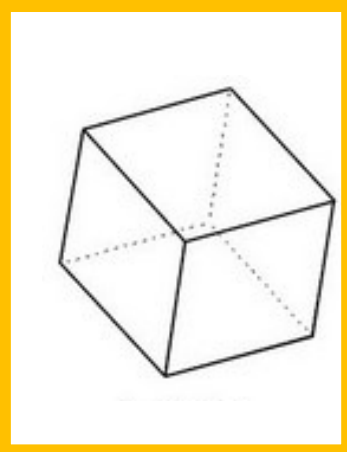
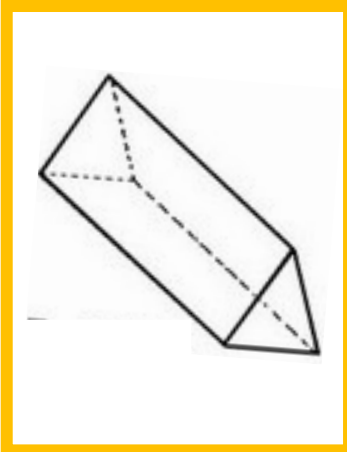

JEU PORTRAIT SOLIDES

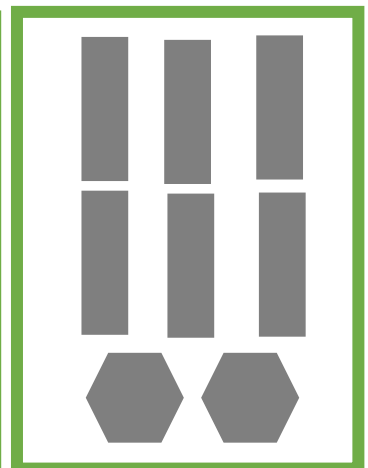
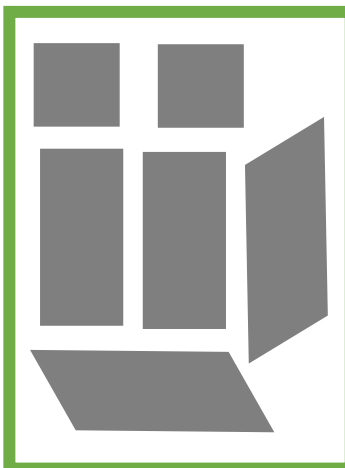
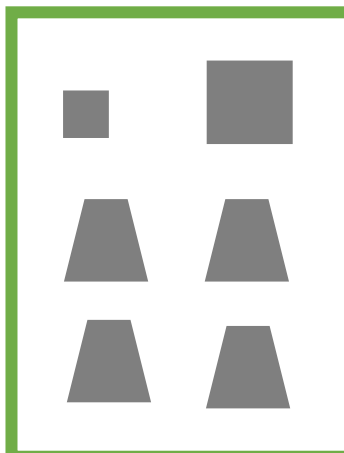
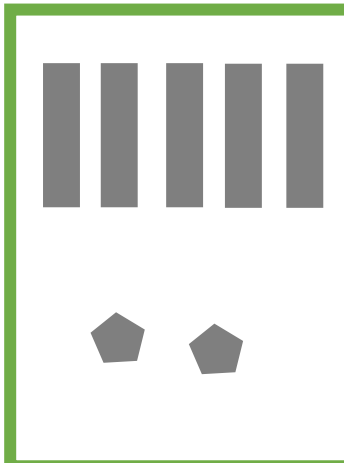
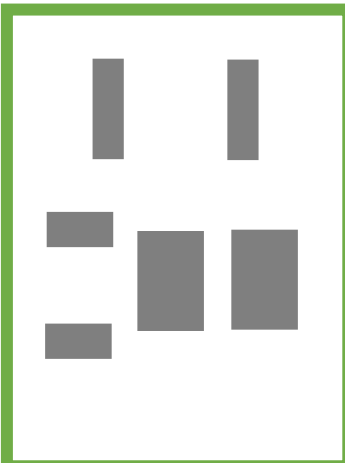
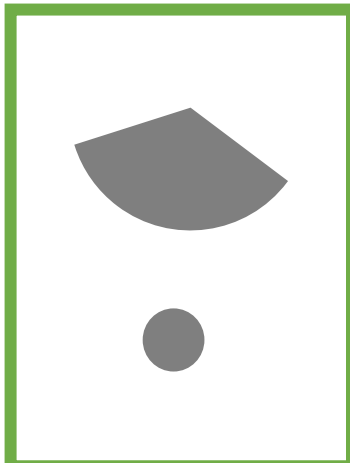
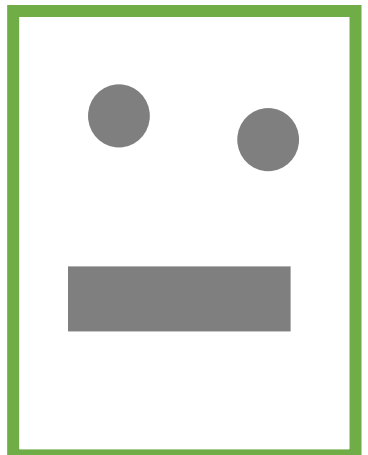
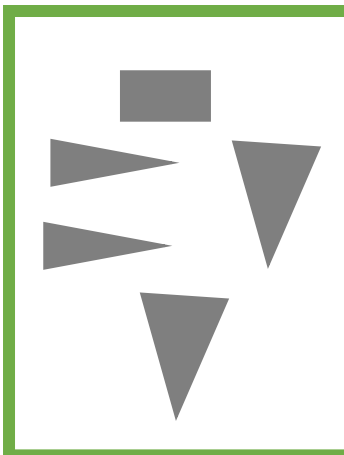
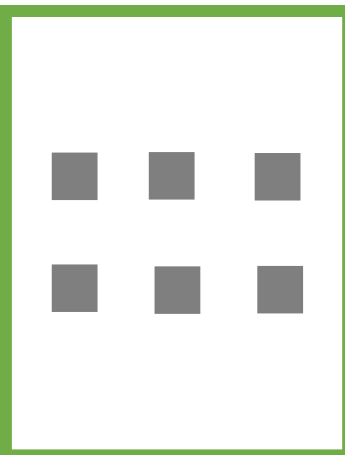
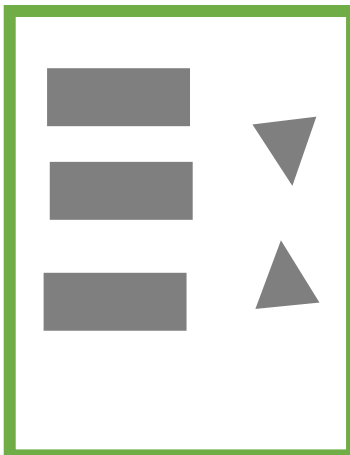

JEU PORTRAIT SOLIDES

nb de faces : 5

nb d'arêtes : 9

nb de sommets : 6

nb de faces : 6

nb d'arêtes : 12

nb de sommets : 8

nb de faces : 5

nb d'arêtes : 8

nb de sommets : 5

nb de faces : 3

nb d'arêtes : 2

nb de sommet : 0

nb de faces : 2

nb d'arête : 1

nb de sommet : 1

nb de faces : 6

nb d'arêtes : 12

nb de sommets : 8

nb de faces : 7

nb d'arêtes : 15

nb de sommets : 10

nb de faces : 9

nb d'arêtes : 16

nb de sommets : 9

nb de faces : 4

nb d'arêtes : 6

nb de sommets : 4

nb de faces : 3

nb d'arêtes : 2

nb de sommet : 0

nb de faces : 6

nb d'arêtes : 12

nb de sommets : 8

nb de faces : 6

nb d'arêtes : 12

nb de sommets : 8

nb de faces : 5

nb d'arêtes : 8

nb de sommets : 5

nb de faces : 6

nb d'arêtes : 12

nb de sommets : 8

nb de faces : 3

nb d'arêtes : 2

nb de sommet : 0

nb de faces : 8

nb d'arêtes : 16

nb de sommets : 12